

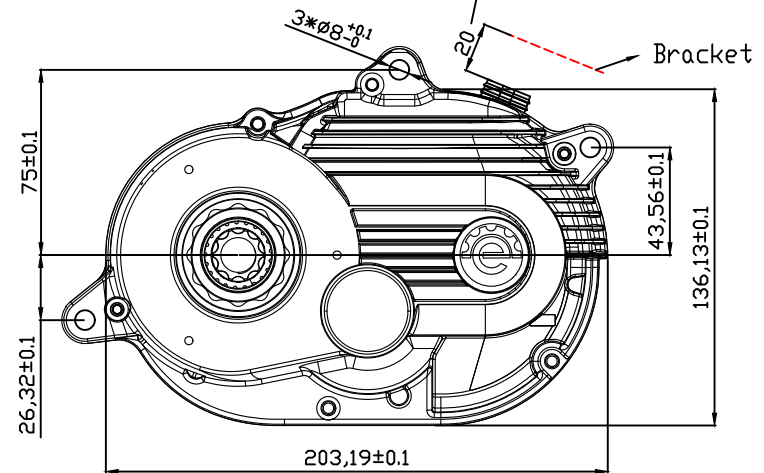

Distance between motor rubber tubing and frame adapter is at least 20mm.

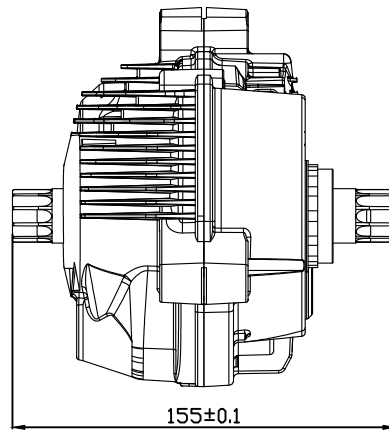
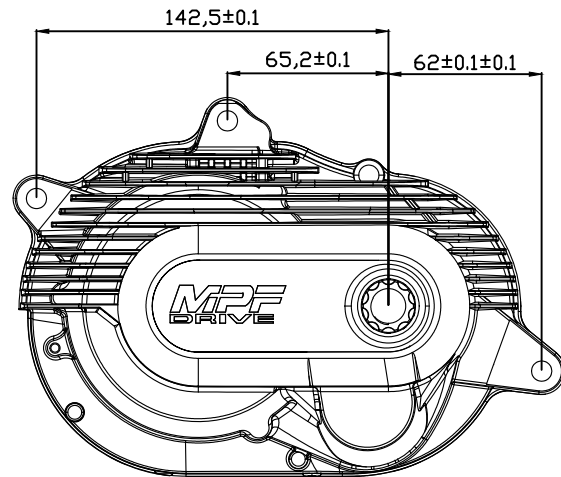

 UNIQUE PRODUCT & DESIGN CO., LTD.		TEL:(06)2536767 FAX:(06)2530998		
DWG FILE		DRAWER	DATE 2020.08.06	Unspecified tolerances >0 ±0.1 >5 ±0.2 >25 ±0.3 >100 ±0.5 >250 ±0.8 >1000 ±1.5
DRAW NAME	MPF 6S (155L)	DESIGNER	DATE	
CART STYLE	T	CHECKER	DATE	
PAPER SIZE	A4	APPROVER	DATE	
Scale		PROJECTION	 UNIT MM	PROCESS
Release level		WORK DIR :	NOTE	SHEET 1 of 1

Paper size	A4
Scale	
Release level	